



# FMSI EDELMANN FITTINGS

PROBLEM SOLVING AUTOMOTIVE HARDWARE



PLATE SCREWS  
DOOR PANELS  
PUSH PINS  
SPLASH PANELS  
SKID PLATES

*The Official Guide Book*  
**TRIM PANELS/BODY CLIPS**

---

SKID PLATES • SPLASH PANELS • PUSH PINS • DOOR PANELS • PLATE SCREWS

---



# FMSI EDELMANN FITTINGS

## THE OFFICIAL TRIM PANELS/ BODY CLIPS GUIDE

AUTOMOTIVE CLIPS AND FASTENERS ASSORTMENTS

### PUSH PIN & PHILIPS SCREW RETAINER ASSORTMENT

REPLACE OR HARDWARE - REPAIR LOOSE OR BROKEN RETAINERS

RE-INSTALL PANELS SECURELY WITH REPAIR HARDWARE  
**0058** - Most popular retainer assortment

**Part #**  
**0058**

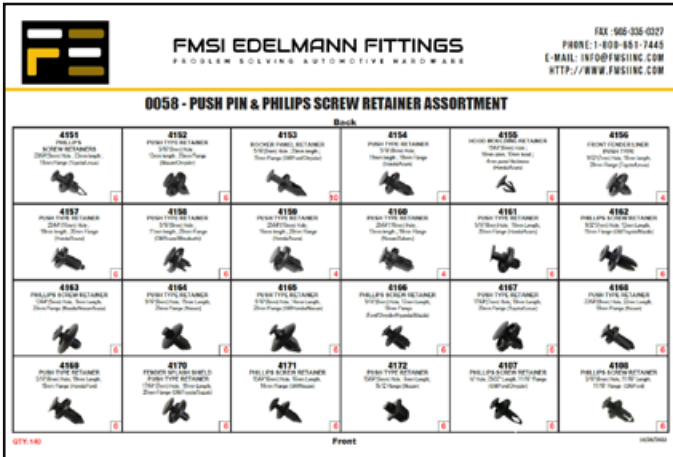

### Retainers for

- Cowl vent screen
- Inner fender
- Speakers
- Door sill trim
- Fender and rocker panels
- Wheel openings
- Rad shield etc



**140**  
**PCS**

TOTAL PIECES: 140  
 TOTAL SKUS: 24

### B I L L O F M A T E R I A L S

#### Item # - Description -

#### Quantity

0066 -	24 HOLE PLASTIC BOX -	1 (Qty.)
4108 -	COWL VENT RETAINER -	6 (Qty.)
4111 -	COWL VENT RETAINER -	6 (Qty.)
4151 -	PUSH PINS RETAINERS -	6 (Qty.)
4152 -	PUSH TYPE RETAINER -	6 (Qty.)
4153 -	ROCKER PANEL RETAINER -	10 (Qty.)
4154 -	PUSH TYPE RETAINER -	4 (Qty.)
4155 -	HOOD MOULDING RETAINER -	6 (Qty.)
4156 -	FRONT FENDER LINER PUSH TYPE -	4 (Qty.)
4157 -	PUSH TYPE RETAINER -	6 (Qty.)
4158 -	PUSH TYPE RETAINER -	6 (Qty.)
4159 -	PUSH TYPE RETAINER -	4 (Qty.)
4160 -	PUSH TYPE RETAINER -	4 (Qty.)
4161 -	FRONT FENDER PUSH TYPE RETAINER -	6 (Qty.)
4162 -	TOYOTA PHILLIPS SCREW RETAINER -	6 (Qty.)
4163 -	MAZDA PHILLIPS SCREW RETAINER -	6 (Qty.)
4164 -	NISSAN PUSH TYPE RETAINER -	6 (Qty.)
4165 -	HONDA PUSH TYPE RETAINER -	6 (Qty.)
4166 -	MAZDA/FORD PHILLIPS SCREW RETAINER -	6 (Qty.)
4167 -	TOYOTA PUSH TYPE RETAINER -	6 (Qty.)
4168 -	NISSAN PUSH TYPE RETAINER -	6 (Qty.)
4169 -	HONDA PUSH TYPE RETAINER -	6 (Qty.)
4170 -	TOYOTA FENDER SPLASH SHIELD PUSH TYPE RETAINER -	6 (Qty.)
4171 -	GM/NISSAN PHILLIPS SCREW RETAINER -	6 (Qty.)
4172 -	NISSAN PUSH TYPE RETAINER -	6 (Qty.)

# FMSI EDELMANN FITTINGS

## THE OFFICIAL TRIM PANELS/ BODY CLIPS GUIDE

AUTOMOTIVE CLIPS AND FASTENERS ASSORTMENTS



### SKID PLATE & SPLASH SHIELD ASSORTMENT REPLACEMENT

#### REPLACEMENT OE & REPAIR HARDWARE FOR SKID PLATES & SPLASH SHIELDS

**Part #**  
**0060**



**MASTER KIT -**  
**ALL MAKES & MODELS**



**3 BOX FULL COVERAGE**

**TOTAL PIECES: 534**  
**TOTAL SKUS: 65**

#### BILL OF MATERIALS

Item # -	Description -	Quantity	Item # -	Description -	Quantity
0066 -	24 HOLE PLASTIC BOX -	3 (Qty.)	8116 -	5/16"(8MM)SPLASH SHIELD RETAINER -	6 (Qty.)
1722 -	3/16" PUSH ON NUTS-	10(Qty.)	8120 -	9/32"(7MM) SPLASH SHIELD RETAINER -	12 (Qty.)
1723 -	1/4" PUSH ON NUTS-	10(Qty.)	8121 -	9/32"(7MM)SPLASH SHIELD RETAINER -	12 (Qty.)
1730 -	6MM x 1.0 PUSH ON NUT METRIC -	10(Qty.)	8123 -	8-1.25 x 20MM SPLASH SHIELD RETAINER BOLT-	8(Qty.)
1731 -	8MM x 1.25 PUSH ON NUT METRIC -	10(Qty.)	8124 -	8-1.25X30MM SPLASH SHIELD RETAINER BOLT-	8(Qty.)
1732 -	M10 x 1.5 PUSH ON NUT METRIC -	10(Qty.)	8126 -	9/32"(7MM)SPLASH SHEILD RETAINER -	6 (Qty.)
1735 -	3/16" THREAD CUTTING NUT -	10(Qty.)	8130 -	5/16"(8MM)PHILLIPS SCREW RETAINER SPLASH SHIELD -	6 (Qty.)
1736 -	1/4" THREAD CUTTING NUT -	6(Qty.)	8131 -	25/64"(10MM) SPLASH SHIELD RETAINER -	12 (Qty.)
1737 -	5/16" THREAD CUTTING NUT -	10(Qty.)	8132 -	SPLASH SHIELD RETAINER BOLT-	8(Qty.)
1740 -	6.3MM THREAD CUTTING NUT -	6(Qty.)	8140 -	5/16"(8MM)SPLASH SHIELD RETAINER -	12 (Qty.)
1741 -	8MM THREAD CUTTING NUT METRIC -	10(Qty.)	8141 -	25/64"(10MM) SPLASH SHIELD RETAINER -	12 (Qty.)
1745 -	6MM - 1.0 LOCK NUT 24MM FLANGE WASHER FACE -	6(Qty.)	8150 -	6.5-1.81X25MM FASTENER SHEET METAL SCREW SPLASH SHIELD -	6 (Qty.)
1746 -	1/4"- 20 W/F LOCK NUTS -	10(Qty.)	8151 -	5/16"(8MM)PHILLIPS SCREW RETAINER SPALSH SHEILD -	6 (Qty.)
1747 -	5/16"- 18 W/F LOCK NUTS-	10(Qty.)	8152 -	21/64"(8.5MM)PUSH TYLE RETAINER SPLASH SHEILD -	6 (Qty.)
2219 -	#8 x 1/2" SELF DRILLING SHEET METAL SCREW -	20(Qty.)	8160 -	9/32"(7MM)SPLASH SHEILD RETAINER -	6 (Qty.)
2222 -	#8 x 3/4" SELF DRILLING SHEET METAL SCREW -	20(Qty.)	8181 -	PUSH TYLE RETAINER SPLASH SHEILD -	6 (Qty.)
2237 -	#10 x 3/4" SELF DRILLING SHEET METAL SCREW -	10(Qty.)	8183 -	¼"(6.3MM)SLPASH SHEILD RETAINER -	6 (Qty.)
2252 -	#12 x 3/4" SELF DRILLING SHEET METAL SCREW -	10(Qty.)	8184 -	PUSH TYLE RETAINER SPLASH SHIELD -	6 (Qty.)
2263 -	#14 x 3/4" SELF DRILLING SHEET METAL SCREW -	8(Qty.)	8190 -	#10(4.8MM ) SPLASH SHIELD GROMMETS -	6 (Qty.)
2275 -	5/16" x 1" SELF DRILLING SHEET METAL SCREW -	6(Qty.)	M600 -	6MM NUT -	6(Qty.)
4152 -	5/16"(8mm) SPLASH SHIELD RETAINER -	12 (Qty.)	M601 -	6MM WASHER -	6(Qty.)
8100 -	VW SPLASH SHIELD RETAINER -	8(Qty.)	M625 -	6MM x 25 -	6(Qty.)
8101 -	VW SPLASH SHIELD RETAINER -	8(Qty.)	M0800 -	8MM NUT -	6(Qty.)
8102 -	VW SPLASH SHIELD RETAINER SCREW -	8(Qty.)	M0801 -	8MM WASHER -	6(Qty.)
8104 -	VW SPLASH SHIELD RETAINER SCREW -	8(Qty.)	M0825 -	8MM x 25 -	6(Qty.)
8105 -	VW SPLASH SHIELD RETAINER NUT -	8(Qty.)	S-104 -	¼"x 1" Bolt -	6 (Qty.)
8107 -	VW SPLASH SHIELD RETAINER SCREW -	8(Qty.)	S-144 -	¼" Flat Washer -	6 (Qty.)
8108 -	VW SPLASH SHIELD RETAINER SCREW/NUT -	8(Qty.)	S-146 -	1/4" FLANGE NUT -	10(Qty.)
8109 -	WASHER FOR 8108 -	8(Qty.)	S-149 -	¼" Nut -	6 (Qty.)
8111 -	5MM STUD SIZE FOR SPLASH SHEILD -	6 (Qty.)	S-204 -	5/16"x 1" Bolt -	6 (Qty.)
8112 -	11/64"(4.5MM) SPLASH SHIELD FASTENER -	6 (Qty.)	S-244 -	5/16" Flat Washer -	6 (Qty.)
8113 -	11/64"(4.5)SPLASH SHIELD FASTENER SPEED NUT -	6 (Qty.)	S-246 -	5/16" FLANGE NUT -	10(Qty.)
8115 -	5/16"(8MM)SPLASH SHIELD FASTENER -	6 (Qty.)	S-249 -	5/16" Nut -	6 (Qty.)



# FMSI EDELMANN FITTINGS

## THE OFFICIAL TRIM PANELS/ BODY CLIPS GUIDE

AUTOMOTIVE CLIPS AND FASTENERS ASSORTMENTS

### TRIM PANEL CLIP ASSORTMENT

TRIM PANEL CLIP ASSORTMENT  
GM - FORD - CHRYSLER - HONDA - TOYOTA

Part #  
**0368**

FMSI EDELMANN FITTINGS PROBLEM SOLVING AUTOMOTIVE HARDWARE					
FAX: 905-308-8327 PHONE: 1-800-651-7448 E-MAIL: INFO@FMSIINC.COM HTTP://WWW.FMSIINC.COM					
0368 - PANEL AND TRIM CLIP ASSORTMENTS					
<b>4008</b> TRIM PANEL RETAINER FORD - WHITE NYLON (2000-05)	<b>4009</b> TRIM PANEL RETAINER GM - WHITE NYLON (2000-05)	<b>4012</b> TRIM PANEL RETAINER GM - WHITE NYLON (2000-05)	<b>4014</b> TRIM PANEL & HEADLINE RETAINER GM - WHITE NYLON (2000-05)	<b>4017</b> INSULATOR TYPIC. FENDER & BUMPER (SHIELD) RETAINER GM, FORD & CHRYSLER BLACK NYLON (GM: 1988-01, CHRY: 1988-01, FORD: 1988-01)	<b>4018</b> FENDER & BUMPER SHIELD RETAINER GM, FORD, CHRYSLER & BANG BLACK NYLON (GM: 1988-01, CHRY: 1988-01, FORD: 1988-01, BANG: 1988-01)
<b>4020</b> TRIM PANEL RETAINER FORD/CHRYSLER 1988 ON TRUCK LID LATCH CHRYSLER TRUCK LID UP BLACK NYLON (GM: 1988-01, FORD: 1988-01)	<b>4024</b> SEAT BACK PANEL RETAINER FORD - WHITE NYLON (1987-01)	<b>4025</b> DOOR TRIM PANEL RETAINER FORD - BLACK NYLON (1987-01)	<b>4027</b> TRIM PANEL RETAINER FORD TRUCK LID UP BLACK NYLON (2000-05)	<b>4028</b> HOOD INSULATION RETAINER FORD BUCKETS EXPLORER & BUCKET BLACK NYLON (1987-01)	
<b>4015</b> SPRAY PANEL (L) & WHEEL WELL COVER RETAINER BLACK NYLON (GM: 1988-01, CHRY: 1988-01)	<b>4016</b> DASHBOARD RETAINER FORD TRUCK LID UP BLACK NYLON (1987-01)	<b>4022</b> HOOD INSULATION RETAINER FORD BLACK NYLON (2000-05)			
<b>4023</b> TRIM PANEL RETAINER FORD - BLACK NYLON			<b>4026</b> INTERIOR SEAT RETAINER FORD TRUCK LID UP BLACK NYLON (1987-01)	<b>4021</b> SEAT RETAINER FORD BUCKETS BLACK NYLON (1987-01)	



### BILL OF MATERIALS

Item # -	Description -	Quantity
0066 -	18 HOLE PLASTIC BOX -	1 (Qty.)
4008 -	DOOR PANEL CLIP -	10 (Qty.)
4009 -	DOOR PANEL CLIP -	10 (Qty.)
4012 -	DOOR PANEL CLIP -	10 (Qty.)
4014 -	DOOR PANEL CLIP -	10 (Qty.)
4015 -	CHRY. 1988-ON CLIP -	10 (Qty.)
4016 -	TRIM PANEL CLIP -	10 (Qty.)
4017 -	TRIM PANEL CLIP -	10 (Qty.)
4018 -	GM-CHRY. PANEL CLIP -	10 (Qty.)
4020 -	FORD/CHRY TRIM RETAINER -	10 (Qty.)
4021 -	FORD TRIM RETAINER -	10 (Qty.)
4022 -	FORD TRIM RETAINER -	10 (Qty.)
4023 -	FORD TRIM RETAINER -	10 (Qty.)
4024 -	FORD TRIM RETAINER -	10 (Qty.)
4025 -	FORD TRIM RETAINER -	10 (Qty.)
4026 -	FORD TRIM RETAINER -	10 (Qty.)
4027 -	FORD TRIM RETAINER -	10 (Qty.)
4028 -	FORD TRIM RETAINER -	10 (Qty.)

**180**  
PCS

TOTAL PIECES: 180  
TOTAL SKUS: 17



### LICENCE PLATE ATTACHING HARDWARE ASSORTMENT

#### LICENCE PLATE ATTACHING HARDWARE

FOR ALL MAKES AND MODELS

**Part #**  
**0433**

0433 - LICENSE PLATES SCREWS, BOLTS & RETAINERS - ASSORTMENT					
<b>4120</b> PLASTIC RETAINER NUT 3/8 Square - #14 coarse Ford/GM/Chrysler imports	<b>4121</b> PLASTIC RETAINER NUT 5/16" - #14 coarse Ford/GM/Chrysler imports	<b>4122</b> PLASTIC RETAINER NUT Ford/GM/Chrysler imports	<b>4142</b> PLASTIC RETAINER NUT Ford/GM/Chrysler imports	<b>4123</b> NUT & SCREW KIT Ford/GM/Chrysler imports	<b>4124</b> NUT & SCREW KIT Ford/GM/Chrysler imports
<b>4125</b> WF METAL SCREW 1/4 X 5/8 Universal	<b>4126</b> BLACK HEX METAL SCREW 1/4" - 1/4 X 5/8 X 5/16 Hex Ford	<b>4127</b> ZINC HEX METAL SCREW 1/4" - 1/4 X 5/8 X 5/16 Hex Ford	<b>4128</b> ZINC GOLD HEX METAL SCREW 6-1.81 X 20mm Honda	<b>4129</b> ZINC-SLOTTED TRUSS HEAD METAL SCREW 1/4 X 5/8 Honda	<b>4130</b> ZINC HEX METAL SCREW 6mm x 16mm
<b>4131</b> ZINC-SLOTTED ROUND HEAD SCREW 5mm-1.0 x 16mm Universal	<b>4132</b> ZINC-GOLD PHILLIPS TRUSS W/FLY-BOLT 5mm-0.8 X 16mm Ford/Chrysler/Mitsubishi Universal	<b>4133</b> ZINC-GOLD PHILLIPS TRUSS W/FLY-BOLT 5mm-0.8 X 12mm Ford/Chrysler/Mitsubishi Universal	<b>M0516</b> BLACK METAL SLOTTED BOLT 5mm-C 8 X 16mm	<b>M0500</b> BLACK METAL NUT 5mm x 8 (M8X5)	<b>M0516</b> BLACK METAL NUT 5mm x 8 (M8X5)
<b>4137</b> BLACK NYLON BOLT 5mm-1.0 x 16mm Universal	<b>4136</b> BLACK NYLON NUT 5mm-1.0 (4137) Universal	<b>4139</b> BLACK NYLON NUT 20X NUT KIT 5/16"-20 X 5/8"	<b>4140</b> ZINC-SLOTTED W/FLY BOLT 1/4" - 20 X 9/16"	<b>4141</b> DEALER PLATE TRUSS SCREW 1/4" X 1/2"	<b>4143</b> PLASTIC RETAINER NUT Ford/GM/Chrysler
FAX: 800-535-6227 PHONE: 1-800-651-7445 E-MAIL: INFO@FMSIINC.COM HTTP://WWW.FMSIINC.COM					



### BILL OF MATERIALS

Item # -	Description -	Quantity
----------	---------------	----------

0066 -	24 HOLE PLASTIC BOX -	1 (Qty.)
4121 -	PLASTIC LIC PLATE NUT -	12 (Qty.)
4122 -	PLASTIC LIC PLATE NUT -	10 (Qty.)
4123 -	LIC SCR&NUT GM&UNIVER -	6 (Qty.)
4124 -	LIC SCR&NUT FORD&UNIVER -	4 (Qty.)
4125 -	14X5/8 LICENSE SCREW -	6 (Qty.)
4126 -	1/4X14X5/16HEX FORD BLACK -	4 (Qty.)
4127 -	1/4X14X5/16HX FRD ZINC -	4 (Qty.)
4128 -	6MMX1.81X20MMX10 HONDA -	4 (Qty.)
4129 -	1/4X5/8 LICENSE SCREW -	6 (Qty.)
4130 -	6MMX16MMX10MM LIC SCREW -	4 (Qty.)
4132 -	5MMX0.8X8MMX12W/F FORD -	6 (Qty.)
4133 -	5MMX0.8X12MMX12W/F FORD -	6 (Qty.)
4136 -	6MMX1.00 NUT FOR 4137 -	6 (Qty.)
4137 -	6MMX1.00X16MM NYL BOLT -	12 (Qty.)
4139 -	1/4-20X5/8 NYLON BOLT -	4 (Qty.)
4140 -	1/4-20X9/16 LIC BOLT -	10 (Qty.)
4141 -	1/4X1/2 DEAL PLATE SCREW -	2 (Qty.)
4142 -	GM LIC PLATE RETAINER -	14 (Qty.)
4143 -	PLASTIC LIC PLATE NUT -	10 (Qty.)
4144 -	LIC PLATE SCR&W GM TRUCK -	4 (Qty.)
M0500 -	5MM NUT 8.8 -	6 (Qty.)
M0516 -	5MM X .08 X 16M BOLT -	6 (Qty.)



**146**  
PCS

TOTAL PIECES: 146  
TOTAL SKUS: 22



# FMSI EDELMANN FITTINGS

## THE OFFICIAL TRIM PANELS/ BODY CLIPS GUIDE

AUTOMOTIVE CLIPS AND FASTENERS ASSORTMENTS

### SPLASH PANEL CLIP ASSORTMENT

#### PUSH ON SPLASH PANEL RETAINER CLIPS

**Part #**  
**0492**

FMSI EDELMANN FITTINGS PROBLEM SOLVING AUTOMOTIVE HARDWARE					
FAX: 800-335-0327 PHONE: 1-800-651-7444 E-MAIL: INFO@FMSIINC.COM HTTP://WWW.FMSIINC.COM					
0492 - SPLASH PANEL RETAINER CLIP ASSORTMENTS					
<b>4015</b> 1/2" Hole Size 130° Stem Length 20° Head Diameter Chrysler	<b>4017</b> 1/2" Hole Size 137° Stem Length 20° Head Diameter GM/Chrysler/Ford	<b>4020</b> 2394° Hole Size 19 Stem Length 16mm Head Diameter Chrysler/Ford	<b>4030</b> 10mm Hole Size 27mm Stem Length 20mm Head Diameter Honda Accord European Fiasco	<b>4031</b> 1564° Hole Size 19mm Stem Length 16mm Head Diameter GM/Chrysler Phillips Screw Retainer	<b>4033</b> 1564° Hole Size 19mm Stem Length 16mm Head Diameter Chrysler/Ford/GM Push Type Retainer
4	10	10	4	4	6
		<b>4035</b> 6 Stem Hole Size 13mm Stem Length 15mm Head Diameter Push Type Retainer	<b>4036</b> 4 Stem Hole Size 14mm Stem Length 12mm Head Diameter Nissan Frontier Truck 1987-On	<b>4037</b> 8mm Hole Size 20mm Flange P/A 11mm Round Drive Type	<b>4038</b> 6mm Hole Size 13mm Stem Length 20mm Flange Round Drive Type
		5	3	3	10
<b>4040</b> 6 Stem Hole Size 15mm Stem Length 15mm Head Diameter Head Drive Type	<b>4042</b> 6mm Hole Size 17mm Stem Length 13mm Head Diameter Toyota Cam & Trucks 2000-On	<b>4043</b> 5 Stem Hole Size 15mm Flange 16° Drive 16mm Head Diameter 16mm Round Plastic Retainer	<b>4044</b> 6.4 Stem Hole Size 16mm Stem Length 16mm Head Diameter Ford Taurus 2008-On Dodge Stratus 2008-On	<b>4045</b> 6mm Hole Size 15mm Stem Length 20mm Head Diameter Honda Civic 1980-On	<b>4046</b> 6mm Hole Size 15mm Stem Length 20mm Flange Round Drive Type
2	4	2	2	2	2



### BILL OF MATERIALS

Item # -	Description -	Quantity
0066 -	24 HOLE PLASTIC BOX -	1 (Qty.)
4015 -	CHRYSLER 1988 - ON RETAINER CLIP -	4 (Qty.)
4017 -	TRIM PANEL CLIP -	10 (Qty.)
4020 -	FORD/CHRYSLER TRIM -	10 (Qty.)
4030 -	SPLASH PANEL RETAINER CLIP -	4 (Qty.)
4031 -	SPLASH PANEL RETAINER CLIP -	4 (Qty.)
4033 -	SPLASH PANEL RETAINER CLIP -	6 (Qty.)
4035 -	SPLASH PANEL RETAINER CLIP -	5 (Qty.)
4036 -	SPLASH PANEL RETAINER CLIP -	3 (Qty.)
4037 -	SPLASH PANEL RETAINER CLIP -	3 (Qty.)
4038 -	SPLASH PANEL RETAINER CLIP -	10 (Qty.)
4040 -	SPLASH PANEL RETAINER CLIP -	2 (Qty.)
4042 -	SPLASH PANEL RETAINER CLIP -	4 (Qty.)
4043 -	SPLASH PANEL RETAINER CLIP -	2 (Qty.)
4044 -	SPLASH PANEL RETAINER CLIP -	2 (Qty.)
4045 -	SPLASH PANEL RETAINER CLIP -	2 (Qty.)
4046 -	SPLASH PANEL RETAINER CLIP -	2 (Qty.)



**73**  
**PCS**











TOTAL PIECES: 73  
TOTAL SKUS: 16



## ERGO TUFLOKS PUSH-TYPE RETAINER ASSORTMENT

**Part #**  
**8637**

### ERGO TUFLOKS PUSH-TYPE RETAINER ASSORTMENT

FMSI EDELMANN FITTINGS PROBLEM SOLVING AUTOMOTIVE HARDWARE		
8637 - ERGO TUFLOKS PUSH-TYPE RETAINER ASSORTMENT		
<p><b>10368</b> 6 Seem Hole Size - 16mm Flange Size 2.0 - 4 Seem Panel Range Black Nylon Push-Type Retainers</p>  <p>25</p>	<p><b>10371</b> 6 Seem Hole Size - 20mm Flange Size 2.0 - 4 Seem Panel Range Black Nylon Push-Type Retainers</p>  <p>30</p>	<p><b>10375</b> 9 Seem Hole Size - 16mm Flange Size 2.95 - 5 Seem Panel Range Black Nylon Push-Type Retainers</p>  <p>30</p>
<p><b>10369</b> 6 Seem Hole Size - 16mm Flange Size 4.0 - 7 Seem Panel Range Black Nylon Push-Type Retainers</p>  <p>25</p>	<p><b>10239</b> 8 Seem Hole Size - 16mm Flange Size 2.7 - 5 Seem Panel Range Black Nylon Push-Type Retainers</p>  <p>35</p>	<p><b>10377</b> 10 Seem Hole Size - 25mm Flange Size 3.0 - 6 Seem Panel Range Black Nylon Push-Type Retainers</p>  <p>20</p>
<p><b>10367</b> 6 Seem Hole Size - 16mm Flange Size 7.0 - 8 Seem Panel Range Black Nylon Push-Type Retainers</p>  <p>25</p>	<p><b>10374</b> 6 Seem Hole Size - 20mm Flange Size 4.0 - 8 Seem Panel Range Black Nylon Push-Type Retainers</p>  <p>25</p>	<p><b>10378</b> 10 Seem Hole Size - 25mm Flange Size 4.0 - 10 Seem Panel Range Black Nylon Push-Type Retainers</p>  <p>18</p>
<p><b>10370</b> 8mm Hole Size - 16mm Flange Size 5.0 - 7 Seem Panel Range Black Nylon Push-Type Retainers</p>  <p>25</p>	<p><b>10372</b> 6 Seem Hole Size - 20mm Flange Size 7.0 - 10 Seem Panel Range Black Nylon Push-Type Retainers</p>  <p>32</p>	

FRONT OF TRAY



### BILL OF MATERIALS

Item # - Description -	Quantity
0087 - 32 HOLE PLASTIC BOX -	1 (Qty.)
10368PK - PUSH-TYPE RETAINER BLACK NYLON -	25 (Qty.)
10371PK - PUSH-TYPE RETAINER BLACK NYLON -	30 (Qty.)
10375PK - PUSH-TYPE RETAINER BLACK NYLON -	30 (Qty.)
10369PK - PUSH-TYPE RETAINER BLACK NYLON -	25 (Qty.)
10239PK - PUSH-TYPE RETAINER BLACK NYLON -	35 (Qty.)
10377PK - PUSH-TYPE RETAINER BLACK NYLON -	20 (Qty.)
10367PK - PUSH-TYPE RETAINER BLACK NYLON -	25 (Qty.)
10374PK - PUSH-TYPE RETAINER BLACK NYLON -	25 (Qty.)
10378PK - PUSH-TYPE RETAINER BLACK NYLON -	20 (Qty.)
10370PK - PUSH-TYPE RETAINER BLACK NYLON -	25 (Qty.)
10372PK - PUSH-TYPE RETAINER BLACK NYLON -	25 (Qty.)



**285**  
PCS

TOTAL PIECES: 290  
TOTAL SKUS: 11







# FMSI EDELMANN FITTINGS

## THE OFFICIAL TRIM PANELS/ BODY CLIPS GUIDE

### AUTOMOTIVE CLIPS AND FASTENERS





#### HANDLE RETAINING CLIP      FORD TRIM PANEL RETAINER      GM TRIM PANEL RETAINER      DOOR TRIM PANEL FASTENERS

<b>PART #</b> <b>4004</b>	<b>OEM:</b> <b>DORMAN:</b>	<b>PART #</b> <b>4008</b>	<b>OEM:</b> 387496S <b>DORMAN:</b> 700-337	<b>PART #</b> <b>4009</b>	<b>OEM:</b> 10126901 <b>DORMAN:</b>	<b>PART #</b> <b>4010</b>	<b>OEM:</b> <b>DORMAN:</b>
	Description : Door & Window Crank Handle Retaining Clip Material : Metal Finish : Zinc		Description : Trim Panel Retainer Type : Double Head Color : White Bottom Head Dia. : 15/16" Top Head Diameter : 29/32" Stem Diameter : 5/16" Stem Length : 15/16" Material : Nylon		Description : Trim Panel Retainer Type : Double Head Color : White Bottom Head Dia. : 15/16" Top Head Diameter : 29/32" Stem Diameter : 5/16" Stem Length : 1-1/4" Material : Nylon		Description : Door Trim Panel Fastener Material : Metal

#### TRIM PANEL RETAINER - GM      GM TRIM PANEL RETAINER      GM & CHRYSLER RETAINER      DASHBOARD RETAINER - FORD

<b>PART #</b> <b>4012</b>	<b>OEM:</b> 3065575 <b>DORMAN:</b> 700-336	<b>PART #</b> <b>4014</b>	<b>OEM:</b> 2064891 9818648 <b>DORMAN:</b>	<b>PART #</b> <b>4015</b>	<b>OEM:</b> 22547243 6501916 11610086 <b>DORMAN:</b> 700-034	<b>PART #</b> <b>4016</b>	<b>OEM:</b> N800387S <b>DORMAN:</b>
	Description : Door Trim Panel Retainer Type : Triple Head Color : White Bottom Head Dia: 7/8" Top Head Diameter : 29/32" Stem Diameter : 5/16" Stem Length : 3/4" Material : Nylon		Description : Door Trim Panel & Headliner Retainer Type : Triple Head Color : White Bottom Head Dia: 3/4" Top Head Diameter : 11/16" Stem Diameter : 5/16" Stem Length : 1/2" Material : Nylon		Description : Splash Shield & Wheel Well Cover Retainer Type : Single Head Color : Black Bottom Head Diameter : 7/8" Top Head Diameter : None Stem Diameter : 5/16" Stem Length : 1-3/32" Material : Nylon		Description : Dashboard Retainer Type : Single Head Color : Black Bottom Head Dia : 1-1/4" Top Head Diameter : None Stem Diameter : 5/16" Stem Length : 1-3/16" Material : Nylon

#### FENDER SHIELD RETAINER      TRIM PANEL RETAINER      TRIM PANEL RETAINER      FASCIA RETAINER

<b>PART #</b> <b>4017</b>	<b>OEM:</b> W705589-SS5YZ ; 6036155-AA 6502078 ; 15958694 ; 1605396 388577-S ; 6030441 ; 111569768 W705589-S300 ; W705589-S	<b>PART #</b> <b>4018</b>	<b>OEM:</b> 10211824 ; 6505411-AA ; 6505425 20732399 ; 332364 ; W701259-S300 389358-S ; 6031321 ; 4004569 3691590 ; 14093311	<b>PART #</b> <b>4020</b>	<b>OEM:</b> N807721-S <b>DORMAN:</b> 963-018	<b>PART #</b> <b>4021</b>	<b>OEM:</b> 5017410-AA 6501544 N803170-S <b>DORMAN:</b>
	GM, FORD, CHRY		GM, FORD, CHRYSLER, AMC		FORD, CHRY		
Description : Radiator Yoke, Fender & Bumper Shield Retainer Type : Single Head Color : Black Bottom Head Dia.: 11/16" Top Head Diameter : None Stem Diameter : 5/16" Stem Length : 13/16" Material : Nylon		Description : Fender & Bumper Shield Retainer Type : Single Head Color : Black Bottom Head Dia.: 11/16" Top Head Diameter : None Stem Diameter : 5/16" Stem Length : 5/8" Material : Nylon		Description : Trim Panel Retainer Type : Single Head Color : Black Top Head Diameter : 5/8" Stem Diameter : 3/8" Stem Length : 3/4" Material : Nylon		Description : Fascia Retainer Type : Retainer Color : Black Top Head Diameter : 7/16" Stem Diameter : 7/32" Stem Length : 1/2" Material : Nylon	

#### HOOD INSULATION RETAINER      HOOD INSULATION RETAINER      SEAT BACK PANEL RETAINER      DOOR TRIM PANEL RETAINER

<b>PART #</b> <b>4022</b>	<b>OEM:</b> 388908S <b>DORMAN:</b>	<b>PART #</b> <b>4023</b>	<b>OEM:</b> 388908S <b>DORMAN:</b>	<b>PART #</b> <b>4024</b>	<b>OEM:</b> 387182S <b>DORMAN:</b> 700-416	<b>PART #</b> <b>4025</b>	<b>OEM:</b> N801925 N801925-S <b>DORMAN:</b> 700-413
	FORD		FORD		FORD		FORD
Description : Hood Insulation Retainer Type : Single Head Head Diameter : 1-3/4" Stem Length : 3/4" Stem Diameter : 3/8" Material : Nylon Color : Black		Description : Hood Insulation Retainer Type : Single Head Head Diameter : 1-3/16" Stem Length : 3/4" Stem Diameter : 3/8" Material : Nylon Color : Black		Description : Seat Back Panel Retainer Type : Double Head Color : Black Bottom Head Diameter : 5/8" Top Head Diameter : 1/2" Stem Diameter : 11/32" Stem Length : 1-1/8" Material : Nylon		Description : Door Trim Panel Retainer Type : Double Head Color : Black Bottom Head Dia : 25/32" Top Head Diameter : 1/2" Stem Diameter : 5/16" Stem Length : 5/8" Material : Nylon	







# FMSI EDELMANN FITTINGS

## THE OFFICIAL TRIM PANELS/ BODY CLIPS GUIDE

### AUTOMOTIVE CLIPS AND FASTENERS







#### INTERIOR TRIM RETAINER      TRIM PANEL RETAINER      HOOD INSULATION RETAINER      PUSH-TYPE RETAINER

<b>PART #</b> <b>4026</b> OEM: 2L1Z-7852140-AA N804349-S DORMAN: 963-114D FORD	<b>PART #</b> <b>4027</b> OEM: 388930S DORMAN: 700-335 FORD	<b>PART #</b> <b>4028</b> OEM: N803613-S DORMAN: FORD	<b>PART #</b> <b>4030</b> OEM: 91502SM4000 DORMAN: 700-864 HONDA
 Description : Interior Trim Retainer Type : Single Head Color : Black Bottom Head Dia : 26MM Top Head Diameter : None Stem Diameter : 8MM Stem Length : 38MM Material : Nylon	 Description : Trim Panel Retainer Type : Single Head Color : Black Bottom Head Diameter : 1" Top Head Diameter : None Stem Diameter : 9/32" Stem Length : 1-1/16" Material : Nylon	 Description : Hood Insulation Retainer Type : Single Head Color : Black Bottom Head Dia: 1-3/4" Top Head Diameter : None Stem Diameter : 5/16" Stem Length : 29/32" Material : Nylon	 Description : Push-Type Retainer Type : Screw-Type with Closed End Head Diameter : 20MM Stem Length : 27MM Drive Type : Slotted/Phillips Hole Size : 10MM Color : Black





#### PUSH-TYPE RETAINER      PUSH-TYPE RETAINER      SCUFF PLATE RETAINER      SPLSH SHLD RETAINER

<b>PART #</b> <b>4031</b> OEM: 94051993 DORMAN: NISSAN	<b>PART #</b> <b>4033</b> OEM: 15149708 W709176S300 6506008AA DORMAN: 963-405 GM.	<b>PART #</b> <b>4035</b> OEM: 00099054929051 N90359101 ; 0009905492 51111908077 DORMAN: BMW , VW / AUDI	<b>PART #</b> <b>4036</b> OEM: 0155301182 DORMAN: NISSAN
 Description: Cowl Panel To Reinforcement Plate & Engine Splash Shield Retainer Type : Screw-Type with Closed End Head Diameter : 9/16" Stem Length : 5/8" Drive Type : Phillips Hole Size : 1/4" Color : Black	 Description : Radiator Wheelhouse, Fender & Front Bumper Cover, Grille, Rocker Push-Type Retainer Head Diameter : 17MM Hole Size : 6MM Stem Length : 16MM Material : Nylon Color : Black	 Description : Bumper, Grille, Scuff Plate & Trim Type : Push-Type Retainer Head Diameter : 15MM Stem Length : 15MM Hole Size : 6.3MM Color : Black	 Description : Splash Shield Retainer Type : Single Head Color : Black Bottom Head Dia : 15MM Top Head Diameter : None Stem Diameter : 4.5MM Stem Length : 14MM Material : Nylon

#### PUSH TYPE RETAINER      PUSH TYPE RETAINER      SCUFF PLATE RETAINER      SPLASH PANEL RETAINER CLIP

<b>PART #</b> <b>4037</b> OEM: 51470390017; 51470146782 51471911992; 2019900292 DORMAN: MERCEDES-BENZ	<b>PART #</b> <b>4038</b> OEM: 51111944537 DORMAN: BMW	<b>PART #</b> <b>4040</b> OEM: 00099054929051 N90359101 ; 0009905492 51111908077 DORMAN: BMW	<b>PART #</b> <b>4041</b> OEM: DORMAN: VW
 Description : Push-Type Retainer Type : Push-Type with Open End Head Diameter : 20MM Stem Length : 14MM Hole Size : 8.5MM Color : Black	 Description : Bumper, Wheel Opening, Scuff Plate & Interior Trim Push-Type Retainer Type : Push-Type with Open End Head Diameter : 20MM Stem Length : 15MM Hole Size : 6.3MM Color : Black	 Description : Bumper, Grille, Scuff Plate & Trim Type : Push-Type Retainer Head Diameter : 15MM Stem Length : 15MM Hole Size : 6.3MM Color : Black	 Description : Splash Shield Push-Type Retainer Material : Nylon Hole Size : 8MM Color : Black Stem Length : 12MM Panel Range : 4-7MM Type : Push-Type with Open End Head Diameter : 16MM

#### SCUFF PLATE RETAINER      SCUFF PLATE RETAINER      PUSH TYPE RETAINER      PUSH-TYPE RETAINER

<b>PART #</b> <b>4042</b> OEM: 9046710162 DORMAN: 963-029 TOYOTA	<b>PART #</b> <b>4043</b> OEM: 51471840960 DORMAN: BMW	<b>PART #</b> <b>4044</b> OEM: W706092S300 6508197AA DORMAN: CHRYSLER, FORD	<b>PART #</b> <b>4045</b> OEM: 91516-SK7-013 DORMAN: 963-620 HONDA
 Description : Scuff Plate Retainer Type : Double Head Bottom Head Diameter : 18MM Top Head Diameter : 13MM Stem Length : 12MM Stem Diameter : 8.5 x 8.5MM Material : Nylon Color : White	 Description : Scuff Plate Retainer Material : Nylon Head Size : 9x12MM Hole Size : 5.7MM Color : White	 Description : Front Air Shield, Splash Guard & Heat Shield Push-Type Retainer Type : Screw-Type with Open End Head Diameter : 18MM Stem Length : 18MM Hole Size : 6.4MM Color : Black	 Description : Splash Shield Push-Type Retainer Type : Screw-Type with Open End Head Diameter : 20MM Stem Length : 15MM Drive Type : Phillips Hex Hole Size : 8MM Color : Black

# FMSI EDELMANN FITTINGS

## THE OFFICIAL TRIM PANELS/ BODY CLIPS GUIDE

### AUTOMOTIVE CLIPS AND FASTENERS

#### PUSH-TYPE RETAINER      HEX WASHER HEAD SCREW      WEATHERSTRIP RETAINER      TRIM PANEL RETAINER

<b>PART #</b> <b>4046</b> <b>OEM:</b> 0155310721 ; 0155305933 W715256S300 ; 0155305933 L33X13209 ; 59114AG000 ; 0155310721 <b>DORMAN:</b> 963-545 NISSAN , INFINITI, SUBARU	<b>PART #</b> <b>4047</b> <b>OEM:</b> 11503791 <b>DORMAN:</b> 	<b>PART #</b> <b>4060</b> <b>OEM:</b> 2964547 <b>DORMAN:</b> CHRYSLER	<b>PART #</b> <b>4062</b> <b>OEM:</b> 411700 <b>DORMAN:</b> 700-331 GM
 <p>Description : Cowl, Bumper &amp; Fender Liner Push-Type Retainer  Type : Push-Type with Drive Pin  Head Diameter : 20MM  Stem Length : 12MM  Hole Size : 8MM  Color : Black</p>	 <p>Head Style : Hex Washer  Screw Size : M6-1.0  Length : 25MM  Across Flats : 10MM  Washer Diameter : 13MM  Point Type : CA  Class : 9.8  Finish : Phosphate</p>	 <p>Description : Weatherstrip Retainer  Type : Single Head  Color : Black  Bottom Head Diameter : 3/8"  Top Head Diameter : None  Stem Diameter : 7/32"  Stem Length : 3/8"  Material : Nylon</p>	 <p>Description : Trim Panel Retainer  Type : Single Head  Color : Black  Bottom Head Diameter : 1/2"  Top Head Diameter : None  Stem Diameter : 9/32"  Stem Length : 3/4"  Material : Nylon</p>





#### BUMPER SHIELD RETAINER      FASCIA RETAINER      BUMPER FASCIA RETAINER      TRIM PANEL RETAINER

<b>PART #</b> <b>4063</b> <b>OEM:</b> W705589-SS5YZ ; 6036155-AA ; 6502078 15958694 ; 1605396 ; 388577-S ; 6030441 11569768 ; W705589-S300 ; W705589-S <b>DORMAN:</b> 700-365 CHRYSLER, FORD, GM	<b>PART #</b> <b>4064</b> <b>OEM:</b> 6501067 <b>DORMAN:</b> CHRYSLER, MASERATI	<b>PART #</b> <b>4065</b> <b>OEM:</b> 10185925 6503768 <b>DORMAN:</b> GM	<b>PART #</b> <b>4066</b> <b>OEM:</b> 21094146 6501301 <b>DORMAN:</b> 963-017 CHRYSLER, GM
 <p>Description : Radiator Yoke, Fender &amp; Bumper Shield Retainer  Type : Single Head  Color : Black  Bottom Head Diameter : 11/16"  Top Head Diameter : None  Stem Diameter : 5/16"  Stem Length : 13/16"  Material : Nylon</p>	 <p>Description : Fascia Retainer  Type : Single Head  Color : Black  Bottom Head Diameter : 25MM  Top Head Diameter : None  Stem Diameter : 7.5MM  Stem Length : 20MM  Material : Nylon</p>	 <p>Description : Bumper Fascia Retainer  Type : Single Head  Color : Black  Bottom Head Diameter : 3/4"  Top Head Diameter : None  Stem Diameter : 11/32"  Stem Length : 1-3/16"  Material : Nylon</p>	 <p>Description : Trim Panel Retainer  Type : Single Head  Color : Black  Bottom Head Diameter : 3/4"  Top Head Diameter : None  Stem Diameter : 11/32"  Stem Length : 7/8"  Material : Nylon</p>

#### REAR HOOD SEAL RETAINER      RADIATOR PANEL RETAINER      BUMPER FASCIA RETAINER      HOOD PROP ROD CLIP

<b>PART #</b> <b>4067</b> <b>OEM:</b> 14074081 <b>DORMAN:</b> GM	<b>PART #</b> <b>4068</b> <b>OEM:</b> <b>DORMAN:</b> 	<b>PART #</b> <b>4069</b> <b>OEM:</b> 1631564 ; N804379-S W706358-S300 <b>DORMAN:</b> 700-330 FORD, GM, HUMMER	<b>PART #</b> <b>4070</b> <b>OEM:</b> 5027550AB <b>DORMAN:</b> CHRYSLER , GM
 <p>Description : Rear Hood Seal Retainer  Type : Single Head  Color : Black  Bottom Head Diameter : 3/4"  Top Head Diameter : None  Stem Diameter : 5/16"  Stem Length : 1-3/8"  Material : Nylon</p>	 <p>Description : Radiator Apron  Type : Single Head  Color : Black  Bottom Head Diameter : 1"  Top Head Diameter : None  Stem Diameter : 7/16"  Stem Length : 13/16"  Material : Nylon</p>	 <p>Description : Bumper Fascia Retainer  Type : Single Head  Color : Black  Bottom Head Diameter : 22MM  Top Head Diameter : None  Stem Diameter : 11MM  Stem Length : 28MM  Material : Nylon</p>	 <p>Description : Natural Nylon Hood Prop Clips  7mm Rod Diameter  Material: Nylon  Type: Rod Clip  Attachment Method: Push-In  Hole Diameter (mm): 10mm  Color/Finish: White</p>

#### HOOD PROP ROD CLIP      HOOD PROP ROD CLIP      HOOD PROP ROD CLIP      HOOD PROP ROD CLIP

<b>PART #</b> <b>4073</b> <b>OEM:</b> J4007456 <b>DORMAN:</b> 45999 CHRYSLER	<b>PART #</b> <b>4076</b> <b>OEM:</b> D5ZZ-16828A <b>DORMAN:</b> FORD	<b>PART #</b> <b>4077</b> <b>OEM:</b> W706009-S300 386299-S <b>DORMAN:</b> FORD	<b>PART #</b> <b>4078</b> <b>OEM:</b> <b>DORMAN:</b> FORD
 <p>Description: Hood Prop Rod Clip  Material: Nylon  Type: Rod Clip  Attachment Method: Push-In  Hole Diameter (in): 5/16 Inch  Total Length: 1-3/8 Inch  Color/Finish: Black</p>	 <p>Description: Hood Prop Rod Clip  Material: Nylon  Type: Rod Clip  Attachment Method: Push-In  Hole Diameter (in): 7/32 Inch  Color/Finish: White</p>	 <p>Description : Hood Prop Rod Clip  Rod Size : 5/16"  Material : Nylon</p>	 <p>Description: Hood Prop Rod Clip  Material: Nylon  Type: Rod Clip  Attachment Method: Push-In  Hole Diameter (in): 5/16 Inch  Color/Finish: White</p>

# FMSI EDELMANN FITTINGS





## THE OFFICIAL TRIM PANELS/ BODY CLIPS GUIDE





### AUTOMOTIVE CLIPS AND FASTENERS



HOOD PROP ROD CLIP		HOOD PROP ROD CLIP		HOOD PROP ROD CLIP		HOOD PROP ROD CLIP	
<b>PART #</b> <b>4079</b>	<b>OEM:</b> W702380S300 <b>DORMAN:</b>	<b>PART #</b> <b>4080</b>	<b>OEM:</b> 91547SE0003 <b>DORMAN:</b>	<b>PART #</b> <b>4081</b>	<b>OEM:</b> 90677-693-003 <b>DORMAN:</b>	<b>PART #</b> <b>4082</b>	<b>OEM:</b> 90677SE0003 <b>DORMAN:</b>
FORD		HONDA		HONDA			
	Description : Hood Prop Rod Clip Rod Size : 6MM Material : Nylon Color/ Finish: Yellow		Description : Hood Prop Rod Clip Rod Size : 6MM Hole Size : 7MM Material : Nylon Colour/Finish: Black		Description : Hood Prop Rod Clip Rod Size : 8MM Hole Size : 9MM sq Material : Nylon Color /Finish: White		Description : Hood Prop Rod Clip Rod Size : 8MM Material : Nylon Color /Finish: Black

HOOD PROP ROD GROMMET		HOOD PROP ROD CLIP		HOOD PROP ROD CLIP		HOOD PROP ROD CLIP	
<b>PART #</b> <b>4083</b>	<b>OEM:</b> 91604SD2013 <b>DORMAN:</b> 45888	<b>PART #</b> <b>4084</b>	<b>OEM:</b> 99604H1400 <b>DORMAN:</b>	<b>PART #</b> <b>4085</b>	<b>OEM:</b> 2422089986 <b>DORMAN:</b>	<b>PART #</b> <b>4086</b>	<b>OEM:</b> 5345514020 <b>DORMAN:</b>
HONDA				NISSAN		TOYOTA	
	Description : Hood Prop Rod Grommet Material : Nylon Color /Finish : Black		Description : Hood Prop Rod Clip Rod Size : 11MM Hole Size : 10 x 12MM Material : Nylon Color /Finish : White		Description : Hood Prop Rod Clip Rod Size : 10MM Hole Size : 8MM Material : Nylon Color / Finish: White		Description : Hood Prop Rod Clip Rod Size : 8MM Hole Size : 14MM Material : Nylon Color /Finish: White

HOOD PROP RD CLIP		HOOD PROP RD CLIP		HOOD PROP ROD CLIP		HOOD PROP ROD CLIP	
<b>PART #</b> <b>4087</b>	<b>OEM:</b> 9095901136 <b>DORMAN:</b>	<b>PART #</b> <b>4088</b>	<b>OEM:</b> 5345533011 5345533010 <b>DORMAN:</b>	<b>PART #</b> <b>4090</b>	<b>OEM:</b> 5345290351 <b>DORMAN:</b>	<b>PART #</b> <b>4091</b>	<b>OEM:</b> <b>DORMAN:</b>
TOYOTA		TOYOTA		TOYOTA			
	Description : Hood Prop Rod Clip Rod Size : 6 & 7MM Material : Nylon Color /Finish : Black		Description : Hood Prop Rod Clip Rod Size : 9MM Hole Size : 10MM sq Material : Nylon Color /Finish : Natural		Description : Hood Prop Rod Clip Rod Size : 6 & 7MM Material : Nylon Colour /Finish: White		Description : Hood Prop Rod Clip Rod Size : 5/16 Inch Material : Nylon Color /Finish: White

HOOD PROP ROD CLIP		PUSH-TYPE RETAINER		PUSH-TYPE RETAINER		AIR CABIN FILTER FASTENER	
<b>PART #</b> <b>4092</b>	<b>OEM:</b> <b>DORMAN:</b>	<b>PART #</b> <b>4093</b>	<b>OEM:</b> 91513-SJK-003 <b>DORMAN:</b>	<b>PART #</b> <b>4094</b>	<b>OEM:</b> 91512SJK003 <b>DORMAN:</b>	<b>PART #</b> <b>4101</b>	<b>OEM:</b> N808342S307 <b>DORMAN:</b>
HONDA		ACURA, HONDA		ACURA, HONDA		FORD	
	Description : Hood Prop Rod Clip Rod Size : 8MM Material : Nylon Color /Finish : Black		Description : Rocker, Pillars, Spoiler, Garnish & Exterior Trim Push-Type Retainer with Sealer Head Diameter : 20mm Stem Length : 13mm Material : Nylon Color : White Used with : 8.5mm Hole		Description : Rocker, Pillars Garnish & Exterior Trim Type : Push-Type Retainer with Sealer Head Diameter : 20MM Stem Length : 13MM Hole Size : 8.5MM Material : Nylon Color : White Includes : Sealer		Description : Air Cabin Filter Fastener Size: 5/8 x 25/32 Material : Metal Colour /Finish : Black Phosphate



# FMSI EDELMANN FITTINGS





## THE OFFICIAL TRIM PANELS/ BODY CLIPS GUIDE

### AUTOMOTIVE CLIPS AND FASTENERS





#### VENT GRILLE NYLON SCREW      VENT GRILLE GROMMET      COWL GRILLE RETAINER      COWL GRILLE SCREW COVER

<b>PART #</b> <b>4102</b> OEM: W704881S300 W701649S <b>DORMAN:</b> FORD	<b>PART #</b> <b>4103</b> OEM: W701650S F7DZ5402316AA F6DZ5402316AA <b>DORMAN:</b> FORD	<b>PART #</b> <b>4104</b> OEM: W704385S300 ; W701221S300 W703919S300 ; W703842S300 <b>DORMAN:</b> FORD	<b>PART #</b> <b>4106</b> OEM: DORMAN: FORD
 <p>Description: Cowl Vent Grille Nylon Screw          Screw Size : #10          Length : 1-1/32"          Head Style : Phillips          Head Diameter : 9/16"          Colour /Finish : Black Nylon          Used with : 19238</p>	 <p>Description : Cowl Top Vent Grille Grommet          Material : Nylon          Color : Natural          Used with : 19237          Fits : -2147483648          Color /Finish: White</p>	 <p>Description : Cowl Grille Fastener          Material : Nylon          Color : Black          Length : 38MM          Finish : Zinc &amp; Yellow          Used with : 20194</p>	 <p>Description : Cowl Grille Screw Cover          Outer Diameter : 13MM          Material : Nylon          Color : Black          Used with : 20193</p>

#### PUSH TYPE RETAINER      PUSH-TYPE RETAINER      PUSH-TYPE RETAINER      PUSH-TYPE RETAINER

<b>PART #</b> <b>4107</b> OEM: DORMAN: GM	<b>PART #</b> <b>4108</b> OEM: 6503163 DORMAN: 961-065 CHRYSLER , GM	<b>PART #</b> <b>4110</b> OEM: C2S9354 ; 20664091 ; 6502790 20664092 ; W705848-S300 N804570-S ; 15773445 ; 4638136 <b>DORMAN:</b>	<b>PART #</b> <b>4114</b> OEM: 90189-06006 DORMAN: TOYOTA
 <p>Description : Push-Type Retainer          Type : Screw-Type with Closed End          Head Diameter : 11/16"          Stem Length : 7/8"          Drive Type : Phillips          Hole Size : 1/4"          Color : Black</p>	 <p>Description : Push-Type Retainer          Type : Screw-Type with Closed End          Head Diameter : 19/32"          Stem Length : 13/16"          Drive Type : Phillips          Hole Size : 5/16"          Color : Black</p>	 <p>Description : Radiator Shroud &amp; Trim Retainer          Type : Screw-Type with Closed End          Head Diameter : 11/16"          Stem Length : 7/8"          Drive Type : Phillips          Hole Size : 1/4"          Color : Black</p>	 <p>Description : Nut Screw          Screw Size : M4.8          Material : Nylon          Color : Natural          Head Diameter : 17MM          Hole Size : 9 x 9MM          Fits : -2147483648</p>

#### NYLON NUT #12 SCREW SIZE      LICENSE PLATE NUT NYLON      LICENSE PLATE SCREW      LICENSE PLATE SCREW

<b>PART #</b> <b>4120</b> OEM: DORMAN: CHRYSLER, FORD	<b>PART #</b> <b>4121</b> OEM: 3907444 DORMAN: 961-351 GM	<b>PART #</b> <b>4122</b> OEM: DORMAN:	<b>PART #</b> <b>4123</b> OEM: 4270974 DORMAN: CHRYSLER
 <p>Description : Nut Screw          Screw Size : #10          Material : Nylon          Color : Black          Fits : -2147483648</p>	 <p>Head Style : Square          Screw Size : 1/4 (#14)          Head Size : 0.600"          Head Thickness : 0.081"          Width : 0.415"          Overall Length : 0.370"          Material : Nylon</p>	 <p>Description: Slot Truss Hd W/dog Pt License Pt          Head Style : Slotted Truss          Screw Size : #14          Length : 5/8"          Head Diameter : 9/16"          Point Type : Dog          Finish : Zinc</p>	 <p>Description: Hex Washer HD License Plate Screw          Head Style : Slotted Hex Washer          Screw Size : #14          Length : 3/4"          Washer Head Diameter : 1/2"          Across Flats : 3/8"          Point Type : A/AB          Finish : Zinc</p>

#### LICENSE PLATE SCW W/NUT      WASHER HEAD SCREW      LICENSE PLATE SCREW      LICENSE PLATE SCREW

<b>PART #</b> <b>4124</b> OEM: 380707S DORMAN:	<b>PART #</b> <b>4125</b> OEM: DORMAN:	<b>PART #</b> <b>4126</b> OEM: N804376-S55 ; N804376-S 1L24-17A386-AA ; N800369-S2 DORMAN: FORD	<b>PART #</b> <b>4127</b> OEM: N800369 DORMAN:
 <p>Description: Sltd Wash HD License Plate Scw W/nut          Head Style : Slotted Hex Washer          Screw Size : #14          Length : 3/4"          Washer Head Diameter : 1/2"          Across Flats : 3/8"          Point Type : A/AB          Finish : Zinc          Includes : 11368 Nylon Nut</p>	 <p>Description: Sltd. Rd. Wash HD. Screw          Head Style : Slotted Round Washer          Screw Size : #14          Length : 5/8"          Washer Head Diameter : 9/16"          Point Type : B          Finish : Zinc          Used with : 8242</p>	 <p>Description: Hex Washer HD License Plate Screw          Head Style : Slotted Hex Washer          Screw Size : #14          Length : 5/8"          Washer Head Diameter : 5/8"          Across Flats : 5/16"          Point Type : B          Finish : Black E-Coat</p>	 <p>Description: Hex Washer HD License Plate Screw          Head Style : Slotted Hex Washer          Screw Size : #14          Length : 5/8"          Washer Head Diameter : 5/8"          Across Flats : 5/16"          Point Type : B          Finish : Zinc</p>

# FMSI EDELMANN FITTINGS

## THE OFFICIAL TRIM PANELS/ BODY CLIPS GUIDE

### AUTOMOTIVE CLIPS AND FASTENERS



#### WASHER HEAD TAP SCREW      LICENSE PLATE SCREW      WASHER HEAD TAP SCREW      HEX HEAD PAN SCREW

<b>PART #</b> <b>4128</b> <b>OEM:</b> 91500-SM4-999AH <b>DORMAN:</b>	<b>PART #</b> <b>4129</b> <b>OEM:</b> <b>DORMAN:</b>	<b>PART #</b> <b>4130</b> <b>OEM:</b> <b>DORMAN:</b>	<b>PART #</b> <b>4132</b> <b>OEM:</b> <b>DORMAN:</b> FORD
 Description : Phillips Hex Wash Head Tap Screw Head Style : Phillips Hex Washer Screw Size : M6-1.81 Length : 20MM Washer Head Diameter : 13MM Across Flats : 10MM Point Type : A/AB Finish : Zinc & Yellow Dichromate	 Description: Slot Truss Head W/dog Pt License Plate Screw Head Style : Slotted Truss Screw Size : #14 Length : 5/8" Head Diameter : 9/16" Point Type : Dog Finish : Zinc	 Description: Hex Washer Head Tap Screw Head Style : Phillips Hex Washer Screw Size : M6-1.81 Length : 16MM Washer Head Diameter : 13MM Across Flats : 10MM Point Type : A/AB Finish : Zinc & Yellow Dichromate	 Description : Phillips Hex Pan Screw with Bolt Head Style : Phillips Hex Washer Screw Size : M6- 0.8 Length : 8MM Finish : Zinc & Gold Dichromate





#### LICENSE PLATE SCREW      NYLON LICENSE PLATE NUT      NYLON LIC PLATE SCREW      LIC. PLATE SCREW & NUT

<b>PART #</b> <b>4133</b> <b>OEM:</b> <b>DORMAN:</b>	<b>PART #</b> <b>4136</b> <b>OEM:</b> <b>DORMAN:</b>	<b>PART #</b> <b>4137</b> <b>OEM:</b> <b>DORMAN:</b>	<b>PART #</b> <b>4139</b> <b>OEM:</b> <b>DORMAN:</b>
 Description: Phillips Pan Wshr Head License Plate Screw Head Style : Phillips Pan Washer Screw Size : M5-0.8 Length : 12MM Washer Head Diameter : 12.7MM Finish : Zinc & Yellow Dichromate	 Description : Black Nylon License Plate Nut Head Style : Hex Washer Screw Size : 1/4-20 Across Flats : 7/16" Washer Diameter : 9/16" Material : Black Nylon	 Description : Black Nylon License Plate Screw Head Style : Slotted Truss Washer Screw Size : 1/4-20 Length : 5/8" Washer Head Diameter : 19/32" Material : Black Nylon	 Description : Black Nylon Lic. Plate Screw & Nut 1/4-20 X 5/8

#### LICENSE PLATE BOLT      PLASTIC RETAINER NUT      LICENSE PLATE SCREW      BUMPER COVER RETAINER

<b>PART #</b> <b>4140</b> <b>OEM:</b> <b>DORMAN:</b>	<b>PART #</b> <b>4143</b> <b>OEM:</b> <b>DORMAN:</b> FORD/GM/CHRYSLER	<b>PART #</b> <b>4144</b> <b>OEM:</b> 16502342 <b>DORMAN:</b> GM	<b>PART #</b> <b>4151</b> <b>OEM:</b> 94853733 9046709101 <b>DORMAN:</b> LEXUS
 Description : Sltd Rd.Washer Head License Plate Bolt Head Style : Slotted Round Washer Screw Size : 1/4-20 Length : 1/2" Washer Head Diameter : 1/2" Finish : Zinc	 Description : Adjusting Nut Material : Nylon Used with : 1/4-28 Screw	 Description: Slot Truss Hd License Plate Screw Head Style : Slotted Truss Screw Size : #14 Length : 1-3/16" Head Diameter : 9/16" Point Type : B Finish : Black E-Coat	 Description : Bumper Cover Push-Type Retainer Type : Screw-Type with Closed End Head Diameter : 18MM Stem Length : 23MM Drive Type : Phillips Hole Size : 9MM Color : Black





#### PUSH-TYPE RETAINER      PUSH-TYPE RETAINER      PUSH-TYPE RETAINER      HOOD INSULATION RETAINER





<b>PART #</b> <b>4152</b> <b>OEM:</b> MR328954, MR328954 0155309321 <b>DORMAN:</b> 700-657 CHRYSLER, NISSAN	<b>PART #</b> <b>4153</b> <b>OEM:</b> F3LB-14K056-AA ; 21075686 F3LY-14570-B ; 90653-HC4-900 6504555 <b>DORMAN:</b> 700-061 GM , FORD	<b>PART #</b> <b>4154</b> <b>OEM:</b> 100653500A 90505SX0003 <b>DORMAN:</b> HONDA, TESLA	<b>PART #</b> <b>4155</b> <b>OEM:</b> 91520SM4C01 <b>DORMAN:</b> HONDA
 Description : Push-Type Retainer Type : Push-Type with Drive Pin Head Diameter : 20MM Stem Length : 9MM Hole Size : 8MM Color : Black	 Description : Bumper, Wheel Well, Cowl Push-type Retainer Material : Nylon Hole Size : 8MM Color : Black Stem Length : 20MM Panel Range : 3.0-8.0MM Type: Push-Type with Closed End Head Diameter : 15MM REPLACE WITH 17222B	 Description : Garnish Side Protector, Front Bumper, Wheel Apron & Engine Under Cover Push-Type Retainer Head Diameter : 18MM Hole Size : 8MM Stem Length : 15MM Material : Nylon Color : Black	 Description : Hood Insulation Retainer Type : Single Head Bottom Head Diameter : 10MM Top Head Diameter : NONE Stem Length : 10MM Stem Diameter : 7.5MM Material : Nylon Color : Black





# FMSI EDELMANN FITTINGS





## THE OFFICIAL TRIM PANELS/ BODY CLIPS GUIDE

### AUTOMOTIVE CLIPS AND FASTENERS

PUSH-TYPE RETAINER		PUSH-TYPE RETAINER		PUSH-TYPE RETAINER		PUSH-TYPE RETAINER	
<b>PART #</b> <b>4156</b>	<b>OEM:</b> 9046707166 <b>DORMAN:</b> 963-562	<b>PART #</b> <b>4157</b>	<b>OEM:</b> 91503SZ5003 91503SZ5003 <b>DORMAN:</b> 963-519	<b>PART #</b> <b>4158</b>	<b>OEM:</b> 909140061; 9046708217; 9046708217 91512SX0003; 91512SX0003 MU000319; 11519949 <b>DORMAN:</b>	<b>PART #</b> <b>4159</b>	<b>OEM:</b> 91503SZ3003 ; 91503SZ3003 909140054 <b>DORMAN:</b> 700-627
TOYOTA, SCION		ACURA, HONDA		ACURA, HONDA, GM		ACURA, HONDA, SUBARU	
	Description : Front Fender Liner Push-Type Retainer Type : Push-Type with Drive Pin Head Diameter : 20MM Stem Length : 8MM* Hole Size : 7MM Color : Black		Description : Front & Rear Bumper Push-Type Retainer Type : Push-Type with Drive Pin Head Diameter : 20MM Stem Length : 18MM Hole Size : 10MM Color : Black		Description : Front Fender, Interior Trim, Washer Tank & Bumper Support Push-Type Retainer Type : Push-Type with Drive Pin Head Diameter : 20MM Stem Length : 11MM Hole Size : 8MM Color : Black		Description : Front Bumper Push-Type Retainer Type : Push-Type with Drive Pin Head Diameter : 20MM Stem Length : 13MM Hole Size : 10MM Color : Black

PUSH-TYPE RETAINER		PUSH-TYPE RETAINER		PUSH-TYPE RETAINER		PUSH-TYPE RETAINER	
<b>PART #</b> <b>4160</b>	<b>OEM:</b> 57728AC090 0155309241 <b>DORMAN:</b> 700-656	<b>PART #</b> <b>4161</b>	<b>OEM:</b> W711712S300 91501S04003 <b>DORMAN:</b> 700-626	<b>PART #</b> <b>4162</b>	<b>OEM:</b> 90467-06017-41; 90467-06017 9926-50-625; 20426301 <b>DORMAN:</b> 700-850	<b>PART #</b> <b>4163</b>	<b>OEM:</b> 80915-29A66; 8942-431-900 9926-50-635; 1395-68-676 <b>DORMAN:</b>
NISSAN, SUBARU		FORD, HONDA		FORD, TOYOTA		MAZDA	
	Description : Bumper Push-Type Retainer Type : Push-Type with Drive Pin Head Diameter : 18MM Stem Length : 15MM Hole Size : 10MM Material : Nylon Color : Black		Description : Front Fender Push-Type Retainer Head Diameter : 20MM Hole Size : 8MM Stem Length : 10MM Material : Nylon Color : Black		Description : Push-Type Retainer Type : Screw-Type with Open End Head Diameter : 15MM Stem Length : 12MM Drive Type : Phillips Hole Size : 7MM Color : Black		Type : Screw-Type with Closed End Head Diameter : 20MM Stem Length : 9MM Drive Type : Phillips Hole Size : 6MM Material : Nylon Color : Black

LICENSE PLATE BOLT		PUSH-TYPE RETAINER		PUSH-TYPE RETAINER		PUSH-TYPE RETAINER	
<b>PART #</b> <b>4164</b>	<b>OEM:</b> 0155306721 <b>DORMAN:</b>	<b>PART #</b> <b>4165</b>	<b>OEM:</b> 63848-01G00; 91545-SE0-003 91545-SE0-003-W1 <b>DORMAN:</b>	<b>PART #</b> <b>4166</b>	<b>OEM:</b> 865952T500; 8659028000HZ 015530038U; 809251833; 8659028000 W705845S300; MB45556143 <b>DORMAN:</b>	<b>PART #</b> <b>4167</b>	<b>OEM:</b> <b>DORMAN:</b>
NISSAN		HONDA, NISSAN		FORD, MAZDA, HONDA		TOYOTA, LEXUS	
	Description : Front & Rear Bumper Cover Push-Type Retainer Type : Push-Type with Drive Pin Head Diameter : 20MM Stem Length : 11MM Hole Size : 8MM Color : Black		Description : Push-Type Retainer Type : Push-Type with Drive Pin Head Diameter : 20MM Stem Length : 8MM Hole Size : 8MM Color : Black		Description : Push-Type Retainer Type : Screw-Type with Open End Head Diameter : 18MM Stem Length : 12MM Hole Size : 8MM Color : Black		Description : Push-Type Retainer Type : Screw-Type with Drive Pin Flange: 20MM Stem Length : 10MM Hole Size : 17/64" (7MM) Color : Black





BUMPER FASCIA RETAINER		PUSH-TYPE RETAINER		PUSH-TYPE RETAINER		PUSH-TYPE RETAINER	
<b>PART #</b> <b>4168</b>	<b>OEM:</b> 638489E001 <b>DORMAN:</b>	<b>PART #</b> <b>4169</b>	<b>OEM:</b> 100653500A 90505SX0003 <b>DORMAN:</b>	<b>PART #</b> <b>4170</b>	<b>OEM:</b> 30020637; 9046707164 0940907332 <b>DORMAN:</b> 700-679	<b>PART #</b> <b>4171</b>	<b>OEM:</b> 94051993 <b>DORMAN:</b>
NISSAN		HONDA, TESLA		SCION, TOYOTA		NISSAN	
	Description : Bumper Fascia Retainer Type : Push-Type with Drive Pin Head Diameter : 18MM Stem Length : 22MM Hole Size : 9MM Color : Black		Description : Garnish Side Protector, Front Bumper, Wheel Apron & Engine Under Cover Push-Type Retainer Head Diameter : 18MM Hole Size : 8MM Stem Length : 15MM Material : Nylon Color : Black		Description : Fender Splash Shield Push-Type Retainer Type : Push-Type with Drive Pin Head Diameter : 20MM Stem Length : 10MM Hole Size : 7MM Color : Black		Description : Cowl Panel To Reinforcement Plate & Engine Splash Shield Retainer Type : Screw-Type with Closed End Head Diameter : 9/16" Stem Length : 5/8" Drive Type : Phillips Hole Size : 1/4" Color : Black





# FMSI EDELMANN FITTINGS





## THE OFFICIAL TRIM PANELS/ BODY CLIPS GUIDE





### AUTOMOTIVE CLIPS AND FASTENERS



PUSH-TYPE RETAINER		PUSH-ON RETAINER		HEAD TAPPING SCREW		BUMPER COVER RETAINER	
<b>PART #</b> <b>4172</b>	<b>OEM:</b> 6681401G00 <b>DORMAN:</b>	<b>PART #</b> <b>8100</b>	<b>OEM:</b> N90796502; N90796501 441863987B <b>DORMAN:</b>	<b>PART #</b> <b>8102</b>	<b>OEM:</b> N90892001 N90775001 <b>DORMAN:</b>	<b>PART #</b> <b>8104</b>	<b>OEM:</b> 4A0805121A <b>DORMAN:</b> 700-081 (Clip)
NISSAN		AUDI, VOLKSWAGEN		AUDI, PORSCHE, VOLKSWAGEN		AUDI, VW	
	Description : Cowl Grille Retainer Type : Push-Type with Open End Head Diameter : 8 x 12MM Stem Length : 8MM Hole Size : 6 x 6MM Material : Nylon Color : Black		Description : Radiator Support & Splash Shield Push-On Retainer Material : Metal Finish : Dacromet Outer Diameter : 30MM		Description : Truss Head Tapping Screw Screw Size : M5-2.12 Length : 19MM Head Style : Torx Truss Drive Type : Torx Drive Size : T25 Head Diameter : 14MM Finish : Black Material : Zinc		Description : Front Fender, Bumper & Engine Cover Retainer Head Diameter : 25MM Stem Length : 22MM Material : Nylon Color : Black Drive Type : Slotted

MOULDING GROMMET		SLOTTED DRIVE COWL FASTENER		U-TYPE NUT ZINC SKID PLATE		METRIC FLAT WASHER	
<b>PART #</b> <b>8105</b>	<b>OEM:</b> 4A0805163 <b>DORMAN:</b> 700-081 (Grommet)	<b>PART #</b> <b>8107</b>	<b>OEM:</b> <b>DORMAN:</b>	<b>PART #</b> <b>8108</b>	<b>OEM:</b> <b>DORMAN:</b>	<b>PART #</b> <b>8109</b>	<b>OEM:</b> <b>DORMAN:</b>
VW, AUDI, SEAT & SKODA		VW, AUDI, SEAT & SKODA		VW			
	Description : Upper & Lower Engine Cover Locking Pin Grommet Material : Nylon Color : Black Width : 20MM Height : 16MM		Description : VW, Audi, Seat & Skoda Cowl Fastener Hole Size: 9/32" (7MM) Head Diameter: 18MM Stem Length: 20MM Material : Steel Colour : Black		Description : Zinc Skid Plate Hole Diameter (in): 1/4 Inch Material: Steel Length (in): 7/8 Inch Length (mm): 22mm Attachment Method: Screw-In Panel Range (in): 1/2 Inch Panel Range (mm): 12mm		Description : Metric Flat Washer 8mm Zinc Bolt Size : 8MM Inner Diameter : 8.4MM Outer Diameter : 15.8MM Thickness : 2MM DIN : 125 Finish : Zinc

PUSH-ON RETAINER		U-TYPE NUT SKID PLATE		COWL FASTENER		PUSH-TYPE RETAINER	
<b>PART #</b> <b>8111</b>	<b>OEM:</b> N90335006 <b>DORMAN:</b>	<b>PART #</b> <b>8112</b>	<b>OEM:</b> <b>DORMAN:</b>	<b>PART #</b> <b>8113</b>	<b>OEM:</b> <b>DORMAN:</b>	<b>PART #</b> <b>8115</b>	<b>OEM:</b> 3C0853934 <b>DORMAN:</b>
AUDI, VW		AUDI		VW, AUDI, SEAT & SKODA		AUDI, VW	
	Description : Splash Shield & Wheel Well Push-On Retainer Material : Metal Finish : Dacromet Outer Diameter : 30MM		Description : U-Type Nut Center Of Hole To Edge: 13MM Panel Range: 2.2MM—5.5MM Width: 19.3MM Length: 23.5MM		Description : VW, Audi, Seat & Skoda Cowl Fastener Head Diameter: 16MM Stem Diameter: 5MM Stem Length: 19MM Material : Steel Colour : Black		Description : Splash Shield & Rocker Moulding Push-Type Retainer Head Diameter : 15MM Stem Length : 10MM Drive Type : 8MM Hex/4MM Allen Hole Size : 8MM Material : Nylon Color : Black





PUSH-TYPE RETAINER		PUSH-TYPE RETAINER		PUSH-TYPE RETAINER		SPASH SHIELD RETAINER	
<b>PART #</b> <b>8116</b>	<b>OEM:</b> N0385501 <b>DORMAN:</b>	<b>PART #</b> <b>8120</b>	<b>OEM:</b> 9046710183; 9046710183 88970767 <b>DORMAN:</b> 700-672	<b>PART #</b> <b>8121</b>	<b>OEM:</b> 9046707201 <b>DORMAN:</b> 700-077	<b>PART #</b> <b>8123</b>	<b>OEM:</b> 90080-11547 <b>DORMAN:</b>
AUDI, VW		LEXUS, SCION, TOYOTA		LEXUS, SCION, TOYOTA		TOYOTA	
	Description : Bumper, Exterior Trim, Fender, Quarter Panel & Wheel Opening Push-Type Retainer Type : Push-Type with Open End Head Diameter : 12MM Stem Length : 11MM Hole Size : 8MM Color : Dark Gray		Description : Front Fender Liner Push-Type Retainer Type : Push-Type with Drive Pin Head Diameter : 18MM Stem Length : 7.5MM Hole Size : 7MM Color : Black		Description : Engine Under Cover Push-Type Retainer Type : Push-Type with Drive Pin Head Diameter : 20MM Stem Length : 10MM Hole Size : 7MM Color : Black		Description : Splash Shield Retainer Bolt Finish: Silver Dacromet M8-1.25 X 20mm 22mm Washer O.D. 12mm Hex











# FMSI EDELMANN FITTINGS





## THE OFFICIAL TRIM PANELS/ BODY CLIPS GUIDE

### AUTOMOTIVE CLIPS AND FASTENERS

SPLASH SHIELD RETAINER		PUSH-TYPE RETAINER		PUSH-TYPE RETAINER		PUSH-TYPE RETAINER	
<b>PART #</b> <b>8124</b>	<b>OEM:</b> 90119-08763 <b>DORMAN:</b> 700-083	<b>PART #</b> <b>8126</b>	<b>OEM:</b> 9046707214 <b>DORMAN:</b> 700-675	<b>PART #</b> <b>8130</b>	<b>OEM:</b> 63876-95596 ; FB01-56-964 90675-SB3-003 ; 90675-SB0-003 <b>DORMAN:</b> 963-111	<b>PART #</b> <b>8131</b>	<b>OEM:</b> 57728AC090 0155309241 <b>DORMAN:</b> 700-656
TOYOTA		SCION, TOYOTA		HONDA, MAZDA, NISSAN		NISSAN, SUBURU	
	Description : Hex Head Splash Shield Retainer Bolt Finish: Black Zinc Phosphate M8-1.25 X 30mm 22mm Washer O.D. 12mm Hex		Description : Radiator Splash Shield Push-Type Retainer Type : Push-Type with Drive Pin Head Diameter : 20MM Stem Length : 9MM Hole Size : 7MM Color : Black		Description : Push-Type Retainer Type : Screw-Type with Open End Head Diameter : 20MM Stem Length : 9MM Hole Size : 8MM Color : Black		Description : Bumper Push-Type Retainer Type : Push-Type with Drive Pin Head Diameter : 18MM Stem Length : 15MM Hole Size : 10MM Color : Black

SPLASH SHIELD RETAINER		PUSH-TYPE RETAINER		PUSH-TYPE RETAINER		HEAD TAPPING SCREW	
<b>PART #</b> <b>8132</b>	<b>OEM:</b> 08146-6162H <b>DORMAN:</b> 700-785	<b>PART #</b> <b>8140</b>	<b>OEM:</b> <b>DORMAN:</b>	<b>PART #</b> <b>8141</b>	<b>OEM:</b> 91503SZ5003 <b>DORMAN:</b> 963-519	<b>PART #</b> <b>8150</b>	<b>OEM:</b> 1125406203 ; 1125406206 9215522000 <b>DORMAN:</b>
NISSAN				ACURA, HONDA		HYUNDAI	
	Description: Engine Splash Shield Retainer Head Diameter (In): 0.389 in Hole Size (in): 0.23 in Length (in): 0.939 in Head Drive Type: Hex Head Tool Size: 10 mm Material (Finish): Steel/ Phosphate		Description: Push-type Retainer Material: Nylon Hole Size (mm): 8mm Attachment Method: Push-On Overall Length (in): 7/16 Inch Overall Length (mm): 11mm Hole Size (in): 5/16 Inch		Description : Front & Rear Bumper Push-Type Retainer Type : Push-Type with Drive Pin Head Diameter : 20MM Stem Length : 18MM Hole Size : 10MM Color : Black		Description : Phillips Truss Head Tapping Screw Screw Size : M6.5-1.81 Length : 25MM Head Style : Truss Head Drive Type : Phillips Head Diameter : 16MM Finish : Black Phosphate Material : Steel

SPLASH SHIELD RETAINER		PUSH-TYPE RETAINER		PUSH-TYPE RETAINER		FORD RETAINER	
<b>PART #</b> <b>8151</b>	<b>OEM:</b> <b>DORMAN:</b>	<b>PART #</b> <b>8152</b>	<b>OEM:</b> 11609417 W715537S300 <b>DORMAN:</b> 961-367	<b>PART #</b> <b>8153</b>	<b>OEM:</b> 11561368 6508712AA <b>DORMAN:</b> 961-363	<b>PART #</b> <b>8160</b>	<b>OEM:</b> <b>DORMAN:</b>
		FORD, GM		GM		FORD	
	Description: Phillips Splash Shield Screw Retainer Head Diameter: 5/16" Stem Diameter: 8MM Stem Length: - Colour: Black Nylon		Description : Fender Apron Retainer Type : Push-Type with Closed End Head Diameter : 19MM Stem Length : 14MM Hole Size : 8.5MM Color : Black		Description : Fender, Wheel & Bumper Retainer Type : Push-Type with Closed End Head Diameter : 18MM Stem Length : 20MM Hole Size : 9.5MM Color : Black		Description: Ford, Cowl, Interior Trim & Splash Shield Retainer Head Diameter: 23MM Stem Diameter: 7.6MM Stem Length: 30MM Colour: Black Nylon

SPLASH SHIELD RETAINER		PUSH-TYPE RETAINER		SPLASH SHIELD RETAINER		SPLASH SHIELD RETAINER	
<b>PART #</b> <b>8181</b>	<b>OEM:</b> W704340-S300 ; N802781-S 55176248 <b>DORMAN:</b> 963-094	<b>PART #</b> <b>8182</b>	<b>OEM:</b> <b>DORMAN:</b>	<b>PART #</b> <b>8183</b>	<b>OEM:</b> <b>DORMAN:</b>	<b>PART #</b> <b>8184</b>	<b>OEM:</b> 6501590 <b>DORMAN:</b> 700-573
FORD, GM							
	Description : Splash Shield & Fascia Retainer Type : Push-Type with Closed End Head Diameter : 1" Stem Length : 7/8" Hole Size : 1/4" Color : Black		Material: Nylon Flange Diameter (in): 1 Inch Flange Diameter (mm): 25mm Length (in): 7/8 Inch Head Diameter (mm): 8mm Shaft Diameter (in): 5/16 Inch Grip Range (mm): 3mm Shaft Diameter (mm): 8mm Number Of Rivets: 25		Description: Splash Shield Retainer Head Diameter: 1/4" Stem Diameter: 6.3MM Stem Length: - Colour: Black Nylon		Description : Splash Shield & Fascia Retainer Type : Push-Type with Closed End Head Diameter : 1" Stem Length : 7/8" Shoulder Length : 1/8" Hole Size : 5/16" Color : Black







# FMSI EDELMANN FITTINGS

## THE OFFICIAL TRIM PANELS/ BODY CLIPS GUIDE



### AUTOMOTIVE CLIPS AND FASTENERS



#### NYLON NUT      ROCKER MOULDING CLIP      ROCKER MOULDING CLIP      ROCKER MOULDING CLIP

<b>PART #</b> <b>8190</b> OEM: 9991-00-501 DORMAN: FORD, MAZDA	<b>PART #</b> <b>9915</b> OEM: 11518357 10443956 DORMAN: GM	<b>PART #</b> <b>9967</b> OEM: 10352799 DORMAN: GM	<b>PART #</b> <b>9969</b> OEM: DORMAN: GM
 Description : Nylon Nut Screw Size : #10 Material : Nylon Color : Natural Width : 12MM Length : 12MM Fits : -2147483648	 Description : Rocker Panel Moulding Clip Material : Nylon Color : White Stem Length : 9/16" Top Head Size : 9/16 x 13/16" Bottom Head Size : 13/16 x 13/16" Hole Size : 7/16"	 Description : Rocker Panel Moulding Clip Material : Nylon Color : Black Stem Length : 11/16" Head Size : 11/16 x 1-5/16" Hole Size : 5/16"	 Description : Rocker Panel Moulding Clip Material : Nylon Color : Black Stem Length : 9/16" Head Size : 15/32 x 1-5/16" Hole Size : 5/16"





#### REAR MOULDING CLIP      REAR MOULDING CLIP      ROCKER PANEL CLIP      ROCKER PANEL CLIP

<b>PART #</b> <b>9990</b> OEM: 10297371 DORMAN: GM	<b>PART #</b> <b>9991</b> OEM: DORMAN: GM	<b>PART #</b> <b>10056</b> OEM: 22603384 DORMAN: GM	<b>PART #</b> <b>10058</b> OEM: 10431761 DORMAN: GM
 Description : Rear Wheel Opening Moulding Clip Material : Nylon Color : Yellow Stem Length : 9/16" Top Head Size : 19/32 x 25/32" Hole Size : 7/16" Includes : Seal	 Description : Rear Wheel Opening Moulding Clip Material : Nylon Color : White Stem Length : 9/16" Top Head Size : 15/32 x 25/32" Bottom Head Size : 1/2 x 25/32" Hole Size : 7/16" Includes : Seal	 Description : Rocker Panel Moulding Clip Material : Nylon Color : White Stem Length : 19/32" Head Size : 3/4 x 1-1/16" Hole Size : 7/16"	 Description : Rocker Panel Moulding Clip Material : Nylon Color : Gray Top Head Size : 11/16 x 1-1/2" Bottom Head Size : 7/8 x 1-9/16" Hole Size : 7/16"

#### ROCKER PANEL CLIP      ROCKER MOULDING CLIP      PUSH-TYPE RETAINER      ROCKER MOULDING CLIP

<b>PART #</b> <b>10059</b> OEM: 25722671 DORMAN: 963-409 GM	<b>PART #</b> <b>10128</b> OEM: 25648693 DORMAN: 963-200 700-000 GM, HUMMER	<b>PART #</b> <b>10239</b> OEM: DORMAN: GM	<b>PART #</b> <b>10357</b> OEM: 10323057 DORMAN: GM
 Description : Rocker Quarter Panel Clip Material : Nylon Color : Gray Length : 2" Width : 7/8"	 Description : Rocker Quarter Panel Moulding Clip Material : Nylon Color : Gray Length : 2" Width : 7/8"	 Description : Push-type Retainer Flange Size : 19MM Panel Range : 2.7 - 5.3MM Hole Size : 8.5MM Color : Black Material : Nylon	 Description : Rocker Panel Moulding Clip Material : Nylon Color : White Stem Length : 14MM Top Head Size : 12 x 20MM Bottom Head Size : 12 x 24MM Hole Size : 9MM

#### PUSH-TYPE RETAINER      PUSH-TYPE RETAINER      PUSH-TYPE RETAINER      PUSH-TYPE RETAINER

<b>PART #</b> <b>10367</b> OEM: DORMAN: GM	<b>PART #</b> <b>10368</b> OEM: DORMAN: GM	<b>PART #</b> <b>10369</b> OEM: DORMAN: GM	<b>PART #</b> <b>10370</b> OEM: DORMAN: GM
 Description : Push-type Retainer Flange Size : 14MM Panel Range : 7.0 - 9.5MM Hole Size : 6.5MM Color : Black Material : Nylon	 Description : Push-type Retainer Flange Size : 18MM Panel Range : 2.0 - 4.5MM Hole Size : 6.5MM Color : Black Material : Nylon	 Description : Push-type Retainer Flange Size : 18MM Panel Range : 4.5 - 7.0MM Hole Size : 6.5MM Color : Black Material : Nylon	 Description : Push-type Retainer Flange Size : 19MM Panel Range : 5.0 - 7.0MM Hole Size : 8MM Color : Black Material : Nylon



# FMSI EDELMANN FITTINGS

## THE OFFICIAL TRIM PANELS/ BODY CLIPS GUIDE





### AUTOMOTIVE CLIPS AND FASTENERS

#### PUSH-TYPE RETAINER

#### PUSH-TYPE RETAINER

#### PUSH-TYPE RETAINER

#### PUSH-TYPE RETAINER





<b>PART #</b> <b>10371</b> <b>OEM:</b> <b>DORMAN:</b>	<b>PART #</b> <b>10372</b> <b>OEM:</b> <b>DORMAN:</b>	<b>PART #</b> <b>10374</b> <b>OEM:</b> <b>DORMAN:</b>	<b>PART #</b> <b>10375</b> <b>OEM:</b> <b>DORMAN:</b>
 <p>Description : Push-type Retainer          Flange Size : 20MM          Panel Range: 2.0 - 4.5MM          Hole Size : 8.5MM          Color : Black          Material: Nylon</p>	 <p>Description : Push-type Retainer          Flange Size : 20MM          Panel Range: 7.0 - 10.0MM          Hole Size : 8.5MM          Color : Black          Material: Nylon</p>	 <p>Description : Push-type Retainer          Flange Size : 20MM          Panel Range: 4.5 - 7.0MM          Hole Size : 8.5MM          Color : Black          Material: Nylon</p>	 <p>Description : Push-type Retainer          Flange Size : 18MM          Panel Range: 2.95 - 5.75MM          Hole Size : 9.5MM          Color : Black          Material: Nylon</p>

#### PUSH-TYPE RETAINER

#### PUSH-TYPE RETAINER

#### ROCKER MOULDING CLIP

#### PILLAR MOULDING CLIP





<b>PART #</b> <b>10377</b> <b>OEM:</b> <b>DORMAN:</b>	<b>PART #</b> <b>10378</b> <b>OEM:</b> <b>DORMAN:</b>	<b>PART #</b> <b>10429</b> <b>OEM:</b> 15221959 <b>DORMAN:</b> 700-057 GM	<b>PART #</b> <b>10481</b> <b>OEM:</b> 15893516 15288146 <b>DORMAN:</b> GM
 <p>Description : Push-type Retainer          Flange Size : 25MM          Panel Range: 3.0 - 6.0MM          Hole Size : 10.5MM          Color : Black          Material: Nylon</p>	 <p>Description : Push-type Retainer          Flange Size : 25MM          Panel Range: 6.0 - 9.0MM          Hole Size : 10.5MM          Color : Black          Material: Nylon</p>	 <p>Description : Rocker Panel Moulding Clip          Material : Nylon          Color : Gray          Length : 1-1/8"          Width : 9/16"          Stem Length : 9/16"          Hole Size : 1/2"</p>	 <p>Description : Windshield Pillar Moulding Clip          Material : Nylon          Color : Gray          Stem Length : 15MM          Top Head Size : 12 x 20MM          Bottom Head Size : 14 x 20MM          Hole Size : 9MM          Includes : Seal</p>

#### BODY SIDE MOULDING CLIP

#### ROCKER MOULDING CLIP

#### ROCKER MOULDING CLIP

#### ROCKER MOULDING CLIP





<b>PART #</b> <b>10482</b> <b>OEM:</b> 11516656; 15282120 15116576 <b>DORMAN:</b> GM	<b>PART #</b> <b>10485</b> <b>OEM:</b> 5480852 <b>DORMAN:</b> GM	<b>PART #</b> <b>10488</b> <b>OEM:</b> <b>DORMAN:</b> GM	<b>PART #</b> <b>10489</b> <b>OEM:</b> <b>DORMAN:</b> GM
 <p>Description : Body Side Moulding Clip          Material : Nylon          Color : Green          Stem Length : 15MM          Head Size : 15 x 38MM          Hole Size : 10MM</p>	 <p>Description : Rocker Panel Moulding Clip          Material : Nylon          Color : Yellow          Stem Length : 9/16"          Top Head Size : 9/16x25/32"          Bottom Head Size : 5/8x13/16"          Includes : Seal</p>	 <p>Description : Rocker Panel Moulding Clip          Material : Nylon          Color : Tan          Stem Length : 11/16"          Head Size : 11/16 x 1-5/16"          Hole Size : 5/16</p>	 <p>Description : Rocker Panel Moulding Clip          Material : Nylon          Color : Gray          Stem Length : 11/16"          Head Size : 11/16 x 1-5/16"          Hole Size : 5/16"</p>

#### ROCKER MOULDING CLIP

#### ROCKER MOULDING CLIP

#### ROOF RAIL MOULDING CLIP

#### ROCKER MOULDING CLIP

<b>PART #</b> <b>10651</b> <b>OEM:</b> 15872008 11561491 <b>DORMAN:</b> 700-055 963-314 GM	<b>PART #</b> <b>10680</b> <b>OEM:</b> 25724529 <b>DORMAN:</b> GM	<b>PART #</b> <b>10823</b> <b>OEM:</b> 11569918 <b>DORMAN:</b> GM	<b>PART #</b> <b>10826</b> <b>OEM:</b> <b>DORMAN:</b> GM
 <p>Description : Rocker Panel Moulding Clip          Material : Nylon          Color : Black          Top Head Size : 20 x 30MM          Hole Size : 17MM          Overall Length : 28MM          Includes : Seal</p>	 <p>Description : Rocker &amp; Grille Moulding Clip          Material : Nylon          Color : White          Stem Length : 9/16"          Top Head Size : 9/16 x 13/16"          Bottom Head Size : 5/8 x 13/16"          Hole Size : 3/8"</p>	 <p>Description : Roof Rail Moulding Clip          Material : Nylon          Color : White          Stem Length : 13MM          Top Head Size : 13 x 30MM          Hole Size : 7MM          Includes : Seal</p>	 <p>Description : Rocker Panel Moulding Clip          Material : Nylon          Color : Black          Stem Length : 15MM          Top Head Size : 12 x 20MM          Bottom Head Size : 12 x 24MM          Hole Size : 9MM</p>

# FMSI EDELMANN FITTINGS

## THE OFFICIAL TRIM PANELS/ BODY CLIPS GUIDE

AUTOMOTIVE CLIPS AND FASTENERS



ROCKER MOULDING CLIP	LICENSE PLATE NUT	LICENSE PLATE BOLT	
----------------------	-------------------	--------------------	--

<p><b>PART #</b> <b>10827</b></p> <p><b>OEM:</b> DORMAN:</p>	<p><b>PART #</b> <b>M0500</b></p> <p><b>OEM:</b> DORMAN:</p>	<p><b>PART #</b> <b>M0516</b></p> <p><b>OEM:</b> DORMAN:</p>	
 <p>Description : White Nylon Moulding Clip Stem Length: 15MM Hole Size: 25/64"(10MM) Top Head Size: 12 x 20MM Color : White Material: Nylon</p>	 <p>Description : Black Metal Nut 5MM-0.8 (for #M0516) Universal Color : Black Material: Metal</p>	 <p>Description : Black Metal Slotted Bolt 5MM-0.8 x 16MM Color : Black Material: Metal</p>	

|--|--|--|--|

--	--	--	--

|--|--|--|--|

--	--	--	--

|--|--|--|--|

--	--	--	--

*The Official Guide Book*  
**TRIM PANELS/BODY CLIPS**



V2

**FMSI EDELMANN FITTINGS**

PROBLEM SOLVING AUTOMOTIVE HARDWARE

CANADA OFFICE: 1070 HERITAGE ROAD, BURLINGTON, ON L7L4X9  
TOLL FREE: 800.651.7445 • FAX: 905.335.1829 • EMAIL: [INFO@FMSIINC.COM](mailto:INFO@FMSIINC.COM) • WEBSITE: [FMSIINC.COM](http://FMSIINC.COM)